

RACE SIGNALS

The meanings of visual and sound signals are stated below. An arrow pointing up or down (↑↓) means that a visual signal is displayed or removed. A dot (•) means a sound; five short dashes (-----) mean repetitive sounds; a long dash (—) means a long sound. When a visual signal is displayed over a class flag, fleet flag, event flag or race area flag, the signal applies only to that class, fleet, event or race area.

Postponement Signals

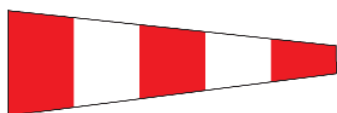

AP Races not started are *postponed*. The warning signal will be made 1 minute after removal unless at that time the race is *postponed* again or *abandoned*.

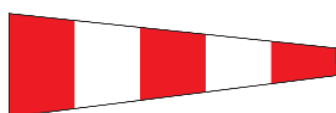

AP over H Races not started are *postponed*. Further signals ashore.

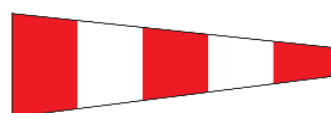

AP over A Races not started are *postponed*. No more racing today.

AP over a Numeral Pennant 1–9

Postponement of 1-9 hours from the scheduled starting time.

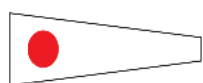

Pennant 1 ↑•• ↓•



Pennant 2 ↑•• ↓•

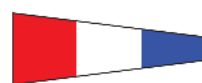

Pennant 3 ↑•• ↓•



Pennant 4 ↑•• ↓•

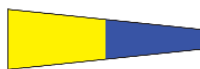

Pennant 5 ↑•• ↓•



Pennant 6 ↑•• ↓•



Pennant 7 ↑•• ↓•



Pennant 8 ↑•• ↓•



Pennant 9 ↑•• ↓•

Abandonment Signals



N All races that have started are *abandoned*. Return to the starting area. The warning signal will be made 1 minute after removal unless at that time the race is *abandoned* again or *postponed*.

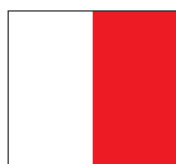

N over H All races are *abandoned*. Further signals ashore.



N over A All races are *abandoned*. No more racing today.

Safety

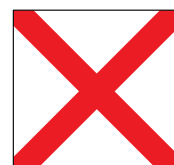

V Monitor communication channel for safety instructions (see rule 37).

Starting signals (see rule 26.1)

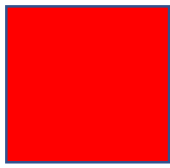

↑• ↓—
Warning signal
 2 minutes to the starting signal

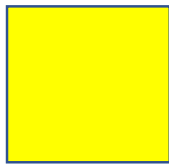

↑• ↓
Preparatory signal
 1 minute to the starting signal



↑• ↓—
Starting signal
 Start



↑• ↓—
Rabbit start
 Start under rule 26.3

Recall Signals



↑•
X Individual recall
 OCS with DSQ
 Used at the finish

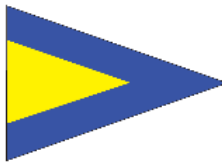

↑•• ↓•
First Substitute General recall. OCS with DSQ and a new start. The warning signal will be made 1 minute after removal.

Other Signals



↑•
L Ashore: A notice to competitors has been posted.
 Afloat: Come within hail or follow this vessel.



— — — —
M The object displaying this signal replaces a missing *mark*.



↑•
Y Wear a personal flotation device (see rule 40).



(no sound)
Orange flag. The staff displaying this flag is one end of the starting line.



(no sound)
Blue flag. The staff displaying this flag is one end of the finishing line.

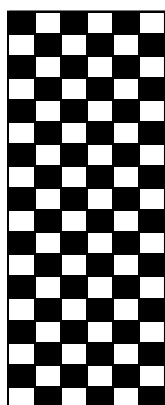

Checked flag (no sound)

Marks both sides of the finish line. This signal replaces the blue flag and shall only be used if published in the Sailing instructions as mark of the finish line.

THE WINDSURFING SLALOM RACING RULES

Date effective: June 2021

These rules have been approved by World Sailing as test rules in accordance with Regulation 28.1.3

FEEDBACK

The World Sailing Racing Rules Committee is interested in feedback on the use of this development rule. Such feedback will allow this development rule to be changed to reflect the needs of the discipline.

A representative of the organizing authority shall send a report to World Sailing promptly after the event describing the experiences with this development rule. If possible, please include views of the competitors. The report shall be emailed to: rules@sailing.org, referencing the DR21 06 – Windsurfing Slalom Racing Rules.

World Sailing

As the leading authority for the sport, World Sailing promotes and supports the protection of the environment in all sailing competitions and related activities throughout the world.
--

Contact Details for the World Sailing Executive Office:

20 Eastbourne Terrace
Paddington
London W2 6LG, UK
Tel +44 (0) 20 3940 4888
Email office@sailing.org
Website sailing.org

CONTENTS

Race Signals	
Online Rules Documents	3
Introduction	4
Definitions	6
Basic Principles	10
Part 1	Fundamental Rules 10
Part 2	When Boards Meet 13
Part 3	Conduct of a Race 16
Part 4	Other Requirements When Racing 21
Part 5	Protests, Redress, Hearings, Misconduct and Appeals 23
Part 6	Entry and Qualification 34
Part 7	Race Organization 36
Appendix A	Scoring 41
Appendix G	Identification on Sails 45
Appendix H	Weighing Clothing and Equipment 46
Appendix J	Notice of Race and Sailing Instructions 48
Notice concerning Notice of Race Guide	xx
Notice concerning Sailing Instructions Guide	xx
Appendix N	International Juries 54
Addenda	
1	Elimination Ladders 57
2	Elimination Schedule 59
3	Courses 60

ONLINE RULES DOCUMENTS

World Sailing has established a single internet address at which readers will find links to all the documents available on the World Sailing website that are mentioned in this book. Those documents are listed below. Links to other rules documents will also be provided at that address.

*The address is: **sailing.org/racingrules/documents**.*

<i>Document</i>	<i>Mentioned in</i>
World Sailing Regulations	Introduction
World Sailing Regulations with the status of a <i>rule</i>	Definition <i>Rule (b)</i>
Up-to-date table of national sail letters	Appendix G
Notice of Race Guide	Appendix K Notice
Sailing Instructions Guide	Appendix L Notice
Guidance on conflicts of interest	Appendix M2.3
Guidance on misconduct	Appendix M5.8

INTRODUCTION

The Windsurfing Slalom Racing Rules (WSRR) have been created as a convenient book for use at windsurfing slalom competition events. The rules are published online only and can be found on the World Sailing website.

Windsurfing slalom is a high-performance sport in which competitors are racing and rounding the marks at high speed. For the safety of the competitors and to make the rules more understandable for competitors, race officials and spectators, the Windsurfing Slalom Racing Rules were written. These rules are as far as possible consistent with the way the competitors and officials already apply the rules in practice.

In Slalom competition, boards may compete in heats and only a limited number of them may advance from round to round.

Terminology

A term used in the sense stated in the Definitions is printed in italics or, in preambles, in bold italics (for example, *racing* and ***racing***).

Each of the terms in the table below is used in *The Windsurfing Slalom Racing Rules* with the meaning given.

Term	Meaning
Board	A sailboard and the competitor on board.
Competitor	A person who races or intends to race in the event.
National authority	A World Sailing member national authority.
Race committee	The race committee appointed under rule 89.2(c) and any other person or committee performing a race committee function.
Racing rule	A rule in The Windsurfing Slalom Racing Rules.
Technical committee	The technical committee appointed under rule 89.2(c) and any other person or committee performing a technical committee function.
Vessel	Any boat or ship.
Heat	Elimination race.
Round	Several heats on the same level.
Elimination	One or more rounds, including finals
Elimination Series	One or more eliminations.

Other words and terms are used in the sense ordinarily understood in nautical or general use.

Hails A language other than English may be used for a hail required by the *rules* provided that it is reasonable for it to be understood by all boards affected. However, a hail in English is always acceptable.

Notation The notation ‘[DP]’ in a rule means that the penalty for a breach of the rule may, at the discretion of the protest committee, be less than disqualification. Guidelines for discretionary penalties are available on the World Sailing website.

Revision These racing rules are revised and published by World Sailing, the international authority for the sport. This edition becomes effective on 1 January 2021 except that for an event beginning in 2020 the date may be postponed by the notice of race and sailing instructions. No changes are contemplated before 2025 but they may be changed and the changes will be announced through national authorities and posted on the World Sailing website.

Appendices When the rules of an appendix apply, they take precedence over any conflicting rules in Parts 1–7 and the Definitions. Each appendix is identified by a letter. A reference to a rule in an appendix will contain the letter and the rule number (for example, ‘rule A1’). The letters I, O and Q are not used to designate appendices in this book.

World Sailing Regulations The Regulations are referred to in the definition *Rule* and in rule 6, but they are not included in this book because they can be changed at any time. The most recent versions of the Regulations are published on the World Sailing website; new versions will be announced through national authorities.

Interpretations World Sailing publishes the following authoritative interpretations of the racing rules:

- Interpretations of the Regulations, for those Regulations that are *rules*.

These publications are available on the World Sailing website. Other interpretations of the racing rules are not authoritative unless approved by World Sailing in accordance with Regulation 28.4.

DEFINITIONS

A term used as stated below is shown in italic type or, in preambles, in bold italic type. The meaning of several other terms is given in Terminology in the Introduction.

Abandon A race that a race committee or protest committee *abandons* is void but may be resailed.

Capsized A board is *capsized* when

- (a) the competitor is water starting,
- (b) the competitor is separated from the board, or
- (c) her sail is in the water.

Clear Astern and Clear Ahead; Overlap One board is *clear astern* of another when her hull is behind a line abeam from the aftermost point of the other board's hull. The other board is *clear ahead*. They *overlap* when neither is *clear astern*. However, they also *overlap* when a board between them *overlaps* both.

Conflict of Interest A person has a *conflict of interest* if he

- (a) may gain or lose as a result of a decision to which he contributes,
- (b) may reasonably appear to have a personal or financial interest which could affect his ability to be impartial, or
- (c) has a close personal interest in a decision.

Finish A board *finishes* when after *starting*, any part of her hull crosses the finishing line from the course side. However, she has not *finished* if after crossing the finishing line she

- (a) takes a penalty under rule 44.2,
- (b) corrects an error in *sailing the course* made at the line, or
- (c) continues to *sail the course*.

Keep clear A board *keeps clear* when another board can sail her course including the manoeuvre to round or pass a *mark* or *obstruction* with no need to take avoiding action.

Leeward and Windward A board's *leeward* side is the side that is away from the wind. However, when sailing by the lee or directly downwind, her *leeward* side is the side on which her sail lies. The other side is her *windward* side. When two boards on the same *tack overlap*, the one on the *leeward* side of the other is the *leeward* board. The other is the *windward* board.

Mark An object the sailing instructions require a board to leave on a specified side, a race committee vessel surrounded by navigable water from which the starting or finishing line extends, and an object intentionally attached to the object or vessel. However, an anchor line is not part of the *mark*.

Mark-room Room for a board, to sail her course to round or pass a *mark* or *obstruction* including space to gybe, if it is part of the manoeuvre.

Obstruction An object that a board could not pass without changing course substantially, if she were sailing directly towards it and one of her hull lengths from it. An object that can be safely passed on only one side and an object, area or line so designated by the sailing instructions are also *obstructions*. However, a board *racing* is not an *obstruction* to other boards unless they are required to *keep clear* of her or, if rule 22.1 applies, avoid her.

Overtaking A board is *overtaking* from the moment she gains an *overlap* from *clear astern* until the moment the overlap is broken.

Party A *party* to a hearing is

- (a) for a protest hearing: a protestor, a protestee;
- (b) for a redress hearing: a board requesting redress or for which redress is requested; a board for which a hearing is called to consider redress under rule 60.3(b); a race committee acting under rule 60.2(b); a technical committee acting under rule 60.4(b);
- (c) for a redress hearing under rule 62.1(a): the body alleged to have made an improper action or omission;
- (d) a person against whom an allegation of a breach of rule 69 is made; a person presenting an allegation under rule 69.2(e)(1);
- (e) a support person subject to a hearing under rule 60.3(d) or 69; any board that person supports; a person appointed to present an allegation under rule 60.3(d).

However, the protest committee is never a *party*.

Postpone A *postponed* race is delayed before its scheduled start but may be started or *abandoned* later.

Pre-start zone The area formed by the starting line and the extensions of the lines from the first mark to the starting marks. During a starting sequence, the *pre-start zone* is part of the course area.

Protest An allegation made under rule 61.2 by a board, a race committee, a technical committee or a protest committee that a board has broken a *rule*.

Racing A board is *racing* from her preparatory signal until she *finishes* and clears the finishing line and *marks* or retires, or until the race committee signals a general recall, *postponement* or *abandonment*.

Room The space a board needs in the existing conditions to comply with her obligations under the rules while manoeuvring promptly in a seamanlike way.

Rounding or Passing A board is *rounding or passing* a *mark* or *obstruction* from the time her course is to begin to manoeuvre to round or pass it, until the *mark* or *obstruction* has been rounded or passed.

Rule

- (a) The rules in this Windsurfing Slalom Racing Rules book, including the Definitions, Race Signals, Introduction, preambles, but not titles;
- (b) World Sailing Regulations that have been designated by World Sailing as having the status of a *rule* and are published on the World Sailing website;
- (c) the prescriptions of the national authority, unless they are changed by the notice of race or sailing instructions in compliance with the national authority's prescription, if any, to rule 88.2;
- (d) the class rules;
- (e) the notice of race;
- (f) the sailing instructions; and
- (g) any other documents that govern the event.

Sail the course A board *sails the course* provided that a string representing her track from the time she begins to approach the starting line from its pre-start side to *start* until she *finishes*, when drawn taut,

- (a) passes each *mark* of the course for the race on the required side and in the correct order,
- (b) touches each *mark* designated in the sailing instructions to be a rounding *mark*, and

(c) passes between the *marks* of a gate from the direction of the previous *mark*.

Start A board *starts* when, her hull having been entirely on the pre-start side of the starting line at or after her starting signal, any part of her hull crosses the starting line from the pre-start side to the course side.

Support Person Any person who

(a) provides, or may provide, physical or advisory support to a competitor, including any coach, trainer, manager, team staff, medic, paramedic or any other person working with, treating or assisting a competitor in or preparing for the competition, or

(b) is the parent or guardian of a competitor.

Tack, Starboard or Port A board is on the *tack*, *starboard* or *port*, corresponding to the competitor's hand that would be nearer the mast if the competitor were in normal sailing position with both hands on the wishbone and arms not crossed. A board is on *starboard tack* when the competitor's right hand would be nearer the mast and is on *port tack* when the competitor's left hand would be nearer the mast.

BASIC PRINCIPLES

SPORTSMANSHIP AND THE RULES

Competitors in the sport of sailing are governed by a body of *rules* that they are expected to follow and enforce. A fundamental principle of sportsmanship is that when a board breaks a *rule* and is not exonerated, she will promptly take an appropriate penalty or action, which may be to retire.

ENVIRONMENTAL RESPONSIBILITY

Participants are encouraged to minimize any adverse environmental impact of the sport of sailing.

KEEP THE FUN IN SLALOM RACING

PART 1

FUNDAMENTAL RULES

1 SAFETY

1.1 Helping Those in Danger

A board or competitor or *support person* shall give all possible help to any person or vessel in danger.

1.2 Life-Saving Equipment and Personal Flotation Devices

A competitor shall carry adequate life-saving equipment, unless her class rules make some other provision. Each competitor is individually responsible for wearing a personal flotation device adequate for the conditions.

2 FAIR SAILING

A competitor shall compete in compliance with recognized principles of sportsmanship and fair play. A competitor may be penalized under this rule only if it is clearly established that these principles have been violated, or he/she was sailing in manner that can be considered as dangerous or reckless. The penalty shall be disqualification that is not excludable.

3 DECISION TO RACE

The responsibility for a competitor's decision to participate in a race or to continue *racing* is his/hers alone.

4 ACCEPTANCE OF THE RULES

4.1 (a) By participating or intending to participate in an event conducted under the *rules*, each competitor and board owner agrees to accept the *rules*.

(b) A *support person* by providing support, or a parent or guardian by permitting their child to enter an event, agrees to accept the *rules*.

4.2 Each competitor and board owner agrees, on behalf of their *support persons*, that such *support persons* are bound by the *rules*.

4.3 Acceptance of the *rules* includes agreement

(a) to be governed by the *rules*;

(b) to accept the penalties imposed and other action taken under the *rules*, subject to the review procedures provided in them, as the final determination of any matter arising under the *rules*;

(c) with respect to any such determination, not to resort to any court of law or tribunal not provided for in the *rules*; and

(d) by each competitor and board owner to ensure that their *support persons* are aware of the *rules*.

4.4 The competitor of each board shall ensure that the competitor and the board's owner are aware of their responsibilities under this rule.

4.5 This rule may be changed by a prescription of the national authority of the venue.

5 RULES GOVERNING ORGANIZING AUTHORITIES AND OFFICIALS

The organizing authority, race committee, technical committee, protest committee and other race officials shall be governed by the *rules* in the conduct and judging of the event.

6 WORLD SAILING REGULATIONS

6.1 Each competitor, board owner and *support person* shall comply with the World Sailing Regulations that have been designated by World Sailing as having the status of a *rule*. These regulations as of 30 June 2020 are the World Sailing:

- Advertising Code
- Anti-Doping Code
- Betting and Anti-Corruption Code
- Disciplinary Code
- Eligibility Code
- Sailor Categorization Code

6.2 Rule 63.1 does not apply unless *protests* are permitted in the Regulation alleged to have been broken.

PART 2

WHEN BOARDS MEET

*The rules of Part 2 apply between boards that are sailing in or near the racing area and intend to **race**, are **racing**, or have been **racing**. However, a board not **racing** shall not be penalized for breaking one of these rules, except rule 2, rule 14 when the incident resulted in injury or serious damage, or rule 23.1.*

SECTION A RIGHT OF WAY

10 ON OPPOSITE TACKS

When boards are on opposite *tacks*, a *port-tack* board shall *keep clear* of a *starboard-tack* board. The *starboard-tack* board has right of way.

11 ON THE SAME TACK, OVERTAKING

An *overtaking* board shall *keep clear* of an *overtaken* board. An *overtaken* board shall not change course if as a result the *overtaking* board would need to change course to continue *keeping clear*.

12 ON THE SAME TACK, NOT OVERLAPPED

When boards are on the same *tack* and not *overlapped*, a board *clear astern* shall *keep clear* of a board *clear ahead*. The board *clear ahead* has right of way.

SECTION B GENERAL LIMITATIONS

14 AVOIDING CONTACT

A board shall avoid contact with another board if reasonably possible, but no board shall be penalized under this rule unless there is contact that causes injury or serious damage.

16 CHANGING COURSE OR SPEED

When a right-of-way board changes course or slows down, she shall give the other board *room to keep clear*.

SECTION C AT MARKS AND OBSTRUCTIONS

When rule 18 applies between two boards, Section A rules do not.

18 ROUNDING OR PASSING MARK OR OBSTRUCTION

18.1 If a board is *leeward* or is *clear ahead* when she begins *rounding or passing* the *mark* or *obstruction*, the *windward* or *clear astern* board at that moment shall thereafter give her *mark-room* until the *mark* no longer influences the course of the board entitled to *mark-room*.

18.2 When a board entitled to *mark-room* must gybe or bear away at the *mark*, until she gybes or bears away, she shall sail no farther from the *mark* than needed to sail that course.

SECTION D OTHER RULES

When rule 22 or 23 applies between two boards, Section A rules do not.

22 CAPSIZED, RESCUING

22.1 If possible, a board shall avoid a board that is *capsized* or has not regained control after *capsizing* or is trying to help a person or vessel in danger.

22.2 If possible, a board that is *capsized* shall not interfere with another board.

23 INTERFERING WITH ANOTHER BOARD

23.1 A board not *racing* shall not interfere with a board that is *racing*.

23.2 A board shall not sail in the course area, defined in the sailing instructions, when races are taking place except when the race is her own. A board that breaks this rule shall be penalized without a hearing and her penalty shall apply to the race sailed nearest to the time of the incident. The penalty for a breach of this rule may be less than disqualification.

23.3 If reasonably possible, a board shall not interfere with a board that is sailing on another leg.

23.4 In the last 30 seconds before the starting signal:

- (a) all boards shall sail in the pre-start zone in the direction of the starting line;
- (b) a board approaching from outside the pre-starting zone is not entitled to *room* or *mark-room* and shall *keep clear* of boards inside the pre-start zone;
- (c) a board that stops, slows down significantly, or one that is not making significant forward progress shall *keep clear* of all others, except when accidentally *capsized*.

PART 3

CONDUCT OF A RACE

25 NOTICE OF RACE, SAILING INSTRUCTIONS AND SIGNALS

- 25.1** The notice of race shall be made available to each board that enters an event before she enters. The sailing instructions shall be made available to each competitor before a race begins.
- 25.2** The meanings of the visual and sound signals stated in Race Signals shall not be changed except under rule 86.1(b). The meanings of any other signals that may be used shall be stated in the notice of race or sailing instructions.
- 25.3** When the race committee is required to display a flag as a visual signal, it may use a flag or other object of a similar appearance, or light signals.
- 25.4** No later than 30 minutes before the first start scheduled, the race committee shall display the course diagrams on the official notice board.

26 STARTING RACES

26.1 Starting Signals

Races shall be started by using the following signals. Times shall be taken from the visual signals; the absence of a sound signal shall be disregarded.

<i>Minutes before starting signal</i>	<i>Visual signal</i>	<i>Sound signal</i>	<i>Means</i>
3	Class flag and heat number		Attention signal
2	Red flag	One	Warning signal
1	Yellow flag; red flag removed	One	Preparatory signal
1/2	Yellow flag removed		30 seconds
0	Green flag; Attention signals removed	One	Starting signal

26.2 Beach Start

- (a) When the starting line is on the beach, or so close to the beach that the competitor must stand in the water to *start*, the start is a beach start.
- (b) The starting stations shall be numbered so that station 1 is the most windward one. Unless the sailing instructions specify some other system, a board's starting station shall be determined
 - (1) by ranking (the highest-ranking board on station 1, the next highest on station 2, and so on), or
 - (2) by draw.
- (c) After boards have been called to take their positions, the race committee shall make the preparatory signal by displaying a red flag with one sound. The starting signal shall be made, at any time after the preparatory signal, by removing the red flag with one sound.
- (d) After the starting signal, each board shall take the shortest route from her starting station to the water and then to her sailing position without interfering with other boards. Part 2 rules will apply when both competitor's feet are on the board.

26.3 Rabbit Start

- (a) At the starting signal displayed under rule 26.1 (green flag), a Rabbit (object or vessel displaying flag R designated in the sailing instructions) shall proceed at high and constant speed to windward from the starting *mark*. The starting line will be between the course side of the starting *mark* and the aftermost point of the Rabbit, until flag R is removed.
- (b) A board that is on the course side of the starting line while flag R is displayed, shall not cross the starting line from the course side.
- (c) After the preparatory signal, a board interfering with the Rabbit shall be disqualified without a hearing by the race committee, even if the race is later *abandoned*. The race committee shall hail or display her sail number, and she shall leave the course area immediately. If the race is restarted or resailed, she shall not sail in it. If she does so, her disqualification shall not be excluded in calculating her series score. If the race was completed but was later *abandoned* by the protest committee, and if the race is resailed, a board disqualified under this rule may sail in it.
- (d) Rules 23.4(a) and (b) do not apply.

27 OTHER RACE COMMITTEE ACTIONS BEFORE THE STARTING SIGNAL

- 27.1** No later than the attention signal, the race committee shall signal or otherwise designate the course to be sailed if the sailing instructions have not stated the course, and it may replace one course signal with another and signal that wearing personal flotation devices is required (display flag Y with one sound).
- 27.2** No later than the warning signal, the race committee may move a starting *mark*.
- 27.3** Before the starting signal, the race committee may for any reason *postpone* (display flag AP, AP over H, or AP over A, with two sounds) or *abandon* the race (display flag N over H, or N over A, with three sounds).

28 SAILING THE RACE

A board shall *start, sail the course* and then *finish*. While doing so, she may leave on either side a *mark* that does not begin, bound or end the leg she is sailing. After *finishing* she shall cross and clear the finishing line immediately.

29 RECALLS

- 29.1** When at a board's starting signal any part of her hull, is on the course side of the starting line, the race committee shall signal a general recall on the starting line or an individual recall on the finishing line as stated in the sailing instructions.
- 29.2** If the race committee acts under rule 29.1 and the board is identified, she shall be disqualified without a hearing, even if the race is later abandoned.
- 29.3** The race committee shall hail or display her sail number, and she shall leave the course area immediately. If the race is restarted or resailed, she shall not sail in it. If she does so, her disqualification shall not be excluded in calculating her series score.
- 29.4** If the race was completed but was later *abandoned* by the protest committee, and if the race is resailed, a board disqualified under this rule may sail in it.

31 TOUCHING A MARK

A board may touch a *mark* but shall not hold on to it.

32 ABANDONING AFTER THE START

After the starting signal, the race committee may *abandon* the race (display flag N, N over H, or N over A, with three sounds) for any reason directly affecting the safety or fairness of the competition.

However, after one board has sailed the course and *finished* within the time limit for that race, if any, the race committee shall not *abandon* the race without considering the consequences for all boards in the race or series.

36 RACES RESTARTED OR RESAILED

If a race is restarted or resailed, a breach of a *rule* in the original race, or in any previous restart or resail of that race, shall not

- (a) prohibit a board from competing unless she has broken rule 29; or
- (b) cause a board to be penalized except under rule 2, 29 or 69 or under rule 14 when she has caused injury or serious damage.

37 SEARCH AND RESCUE INSTRUCTIONS

When the race committee displays flag V with one sound, all boats and official and support vessels shall, if possible, monitor the race committee communication channel for search and rescue instructions.

38 ELIMINATION INCLUDING HEATS

38.1 Elimination procedure

- (a) Competition shall take the form of one or more eliminations. Each of them shall consist of either rounds in a single elimination where only a number of boards with the best scorers advance; or rounds in a double elimination where boards have more than one opportunity to advance.
- (b) Boards shall sail one against another in pairs, or in groups determined by the elimination ladder. The selected form of competition shall not be changed while a round remains uncompleted.

38.2 Seeding and Ranking Lists

- (a) When a seeding or ranking list is used to establish the heats of the first round, places 1–8 (four heats) or 1–16 (eight heats), or others according to the sailing instructions, shall be distributed evenly among the heats.
- (b) For a subsequent elimination, if any, boards shall be reassigned to new heats according to the ranking in the previous elimination.
- (c) The organizing authority's seeding decisions are final.

38.3 Heat Schedule

The schedule of heats shall be posted on the official notice board no later than 30 minutes before the starting signal for the first heat.

38.4 Advancement and Byes

The boards in each heat that will advance to the next round will be announced by the race committee no later than 30 minutes, or as stated in the sailing instructions, before the starting signal for the first heat of the next round. The number advancing may be changed by the protest committee as a result of a redress decision.

PART 4

OTHER REQUIREMENTS WHEN RACING

*Part 4 rules apply only to boards **racing** unless the rule states otherwise.*

SECTION A

GENERAL REQUIREMENTS

40 PERSONAL FLOTATION DEVICES

40.1 Basic Rule

When rule 40.1 is made applicable by rule 40.2, each competitor shall wear a personal flotation device except briefly while changing or adjusting clothing or personal equipment. Wet suits and dry suits are not personal flotation devices.

40.2 When Rule 40.1 Applies

Rule 40.1 applies

- (a) if flag Y was displayed afloat with one sound before or with the warning signal, while *racing* in that race; or
- (b) if flag Y was displayed ashore with one sound, at all times while afloat that day.

However, rule 40.1 applies when so stated in the notice of race or sailing instructions.

41 OUTSIDE HELP

A board shall not receive help from any outside source, except

- (a) help for a competitor who is ill, injured or in danger;
- (b) after a collision, help from the other competitor to get clear.

43 EXONERATION

- 43.1 (a) When as a consequence of breaking a *rule* a board has compelled another board to break a *rule*, the other board is exonerated for her breach.

- (b) When a board is sailing within the *room* or *mark-room* to which she is entitled and, as a consequence of an incident with a board required to give her that *room* or *mark-room*, she breaks a rule of Section A or B of Part 2, she is exonerated for her breach, unless she causes injury or damage.

43.2 A board exonerated for breaking a *rule* need not take a penalty and shall not be penalized for breaking that *rule*.

44 PENALTIES AT THE TIME OF AN INCIDENT

44.1 Taking a Penalty

A board may take a 360°-Turn Penalty when she may have broken one or more rules of Part 2 in an incident while *racing*. The sailing instructions may specify the use of some other penalty. However, if the board caused *injury* or *serious damage* or, despite taking a penalty, gained a significant advantage in the heat or the elimination by her breach, her penalty shall be to retire.

44.2 360°-Turn Penalty

After getting well clear of other boards as soon after the incident as possible, a board takes a 360°-Turn Penalty by promptly making a 360° turn with no requirement for a tack or a gybe. When a board takes the penalty at or near the finishing line, her hull shall be completely on the course side of the line before she *finishes*.

47 TRASH DISPOSAL

Competitors and *support persons* shall not intentionally put trash in the water. This rule applies at all times while afloat. The penalty for a breach of this rule may be less than disqualification.

SECTION B

EQUIPMENT-RELATED REQUIREMENTS

50 COMPETITOR CLOTHING, EQUIPMENT AND WEIGHING

- 50.1** (a) Competitors shall not wear or carry clothing or equipment for the purpose of increasing their weight. However, a competitor may wear a drinking container that shall have a capacity of no more than 1.5 litres.

- (b) Furthermore, a competitor's clothing and equipment shall not weigh more than 8 kilograms, excluding a hiking or trapeze harness. Weights shall be determined as required by Appendix H.

PART 5

PROTESTS, REDRESS, HEARINGS AND MISCONDUCT

SECTION A

PROTESTS; REDRESS; RULE 69 ACTION

60 RIGHT TO PROTEST; RIGHT TO REQUEST REDRESS OR RULE 69 ACTION

60.1 A board may

- (a) protest another board, but not for an alleged breach of a rule of Part 2 or rule 31 unless she was involved in the incident; or
- (b) request redress; or
- (c) report to the protest committee requesting action under rule 60.3(d) or 69.2(b).

60.2 A race committee may

- (a) protest a board, but not as a result of information arising from a request for redress or an invalid *protest*, or from a report from a person with a conflict of interest other than the representative of the board herself;
- (b) request redress for a board; or
- (c) report to the protest committee requesting action under 60.3(d) or 69.2(b).

60.3 A protest committee may

- (a) protest a board, but not as a result of information arising from a request for redress or an invalid *protest*, or from a report from a person with a *conflict of interest* other than the representative of the board herself. However, it may protest a board
 - (1) if it learns of an incident involving her that may have resulted in injury or serious damage, or
 - (2) if during the hearing of a valid *protest* it learns that the board, although not a *party* to the hearing, was involved in the incident and may have broken a *rule*;

- (b) call a hearing to consider redress;
- (c) act under rule 69.2(b); or
- (d) call a hearing to consider whether a *support person* has broken a *rule*, based on its own observation or information received from any source, including evidence taken during a hearing.

60.4 A technical committee may

- (a) protest a board, but not as a result of information arising from request for redress or an invalid *protest*, or from a report from a person with a *conflict of interest* other than the representative of the board herself. However, it shall protest a board if it decides that a board or personal equipment does not comply with the class rules or with rule 50;
- (b) request redress for a board; or
- (c) report to the protest committee requesting action under rule 60.3(d) or 69.2(b).

60.5 However, neither a board nor a committee may protest for an alleged breach of rule 69 or a Regulation referred to in rule 6, unless permitted by the Regulation concerned.

61 PROTEST REQUIREMENTS

61.1 Informing the Protestee

The protesting board shall inform the other board at the first reasonable opportunity. When her *protest* will concern an incident in the racing area, she shall hail ‘Protest’ at the first reasonable opportunity. She shall also inform the race committee on the finishing line of her intention to protest as soon as practicable after she *finishes* or retires and shall inform the protestee that there will be, as soon as possible, a hearing.

61.2 Protest Contents

A protest shall identify the initiator, the respondent and the incident. These requirements shall be met before the beginning of the hearing.

61.3 Protest Time Limit

A *protest* by a board, or by the race committee, technical committee or protest committee about an incident observed in the racing area, shall be delivered orally to the protest committee as soon as reasonably possible after the concerned heat. Other *protests* shall be delivered to the race office as soon as reasonably possible after learning of the reasons to protest. The protest committee shall extend the time if there is good reason to do so.

62 REDRESS

- 62.1** A request for redress or a protest committee's decision to consider redress shall be based on a claim or possibility that a board's score or place in a race or series has been or may be, through no fault of her own, made significantly worse by
- (a) an improper action or omission of the race committee, protest committee, organizing authority or technical committee for the event, but not by a protest committee decision when the board was a *party* to the hearing;
 - (b) giving help (except to herself) in compliance with rule 1.1; or
 - (c) an action of another board or *support person* of that board, that resulted in a penalty under rule 2 or a penalty or warning under rule 69.
- 62.2** A request shall identify the reason for making it. If the request is based on an incident in the racing area, the board shall inform the race committee at the finishing line of her intention to request redress as soon as practicable after she *finishes* or retires. The request shall be delivered to the protest committee as soon as reasonably possible after the concerned heat. Other requests shall be delivered as soon as reasonably possible after learning of the reasons for making the request. The protest committee shall extend the time if there is good reason to do so.

SECTION B HEARINGS AND DECISIONS

63 HEARINGS

63.1 Requirement for a Hearing

A board or competitor shall not be penalized without a protest hearing, except as provided in rules 23.2, 26.3(c), 29.2, 64.5(b), 69, 78.2 and A5.1. A decision on redress shall not be made without a hearing. The protest committee shall hear all *protests* and requests for redress that have been delivered to the protest committee unless it allows a *protest* or request to be withdrawn.

63.2 Time and Place of the Hearing

- (a) For *protests* arising from incidents on the water, the *parties* and their witnesses shall go to the protest committee as soon as reasonably possible after *finishing*. The hearing will start as soon as possible, and heats affected by the protest committee decisions may be postponed accordingly. When two or more hearings arise from the same incident, or from very closely connected incidents, they may be heard together in one hearing.
- (b) For all other *protests*, the *parties* shall go as soon as reasonably possible to the protest committee.
- (c) However, a hearing conducted under rule 69 shall not be combined with any other type of hearing.

63.3 Right to Be Present

- (a) Each *party* to the hearing has the right to be present throughout the hearing of all the evidence. Any witness, other than a member of the protest committee, shall be excluded except when giving evidence.
- (b) If a *party* to the hearing of a *protest* or request for redress does not come to the hearing, the protest committee may nevertheless decide the *protest*.

63.4 Conflict of Interest

- (a) A protest committee member shall declare any possible *conflict of interest* as soon as he is aware of it. A *party* to the hearing who believes a member of the protest committee has a *conflict of interest* shall object as soon as possible.
- (b) A member of a protest committee with a *conflict of interest* shall not be a member of the committee for the hearing, unless
 - (1) all *parties* consent, or
 - (2) the protest committee decides that the *conflict of interest* is not significant.
- (c) When deciding whether a *conflict of interest* is significant, the protest committee shall consider the views of the *parties*, the level of the conflict, the level of the event, the importance to each *party*, and the overall perception of fairness.
- (d) However, for World Sailing major events, or for other events as prescribed by the national authority of the venue, rule 63.4(b) does not apply and a person who has a *conflict of interest* shall not be a member of the protest committee.

63.5 Validity of the Protest or Request for Redress

At the beginning of the hearing the protest committee shall take any evidence it considers necessary to decide whether all requirements for the *protest* or request for redress have been met. If they have been met, the *protest* is valid, and the hearing shall be continued. If not, the committee shall declare the *protest* invalid and close the hearing. If the *protest* has been made under rule 60.3(a)(1), the committee shall also determine whether or not *injury* or *serious damage* resulted from the incident in question. If not, the hearing shall be closed.

63.6 Taking Evidence and Finding Facts

The protest committee may take evidence, including hearsay evidence, of the *parties* present at the hearing and of their witnesses and other evidence it considers necessary and may communicate its decision orally. However, the committee may exclude evidence which it considers is irrelevant or unduly repetitive.

63.7 Conflict Between Rules

If there is a conflict between two or more *rules*, it must be resolved before the first start of the day. The protest committee shall apply the *rule* that it believes will provide the fairest result for all boards affected. Rule 63.7 applies only if the conflict is between rules in the notice of race, the sailing instructions, or any of the other documents that govern the event under item (g) of the definition *Rule*.

63.9 Hearing under Rule 60.3(d) – Support Persons

If the protest committee decides to call a hearing under rule 60.3(d), it shall promptly follow the procedures in rules 63.2, 63.3, 63.4, and 63.6, except that the information given to the *parties* shall be details of the alleged breach and a person may be appointed by the protest committee to present the allegation.

64 DECISIONS

64.1 Standard of Proof, Majority Decisions and Reclassifying Requests

- (a) A protest committee shall make its decision based on a balance of probabilities, unless provided for otherwise in the rule alleged to have been broken.
- (b) Decisions of the protest committee shall be by simple majority vote of all members. When there is equal division of votes cast, the chairman may cast an additional vote.

- (c) The protest committee shall proceed with each case, as a *protest*, request for redress or other type of request, based on the information in the written request or allegation and testimony during the hearing. This permits the type of case to be changed if appropriate.

64.2 Penalties

When the protest committee decides that a board that is a *party* to a protest hearing has broken a *rule* and is not exonerated, it shall disqualify her unless some other penalty applies. A penalty shall be imposed whether or not the applicable *rule* was mentioned in the *protest*. If a board has broken a *rule* when not *racing*, her penalty shall apply to the race sailed nearest in time to that of the incident. However,

- (a) if a board has taken an applicable penalty, she shall not be further penalized under this rule unless the penalty for a *rule* she broke is a disqualification that is not excludable from her series score.
- (b) if the race is restarted or resailed, rule 36 applies.
- (c) when as a consequence of breaking a *rule*, there is minor contact or position changes, no board shall be penalized.

64.3 Decisions on Redress

When the protest committee decides that a board is entitled to redress under rule 62, it shall make as fair an arrangement as possible for all boards affected, whether or not they asked for redress. This may be to advance the board in the proper heat in the next rounds, to adjust the scoring (see rule A9 for some examples), to *abandon* the heat or elimination, to let the results stand or to make some other arrangement. When in doubt about the facts or probable results of any arrangement for the race or series, especially before *abandoning* the race, the protest committee shall take evidence from appropriate sources.

64.4 Decisions on Protests Concerning Class Rules

- (a) When the protest committee finds that deviations in excess of tolerances specified in the class rules were caused by damage or normal wear and do not improve the performance of the board, it shall not penalize her. However, the board shall not *race* again until the deviations have been corrected, except when the protest committee decides there is or has been no reasonable opportunity to do so.

- (b) When the protest committee is in doubt about a matter concerning the measurement of a board, the meaning of a class rule, or damage to a board, it shall refer its questions, together with the relevant facts, to the technical committee. In making its decision, the protest committee shall be bound by the reply of the technical committee.
- (c) When a board is penalized under a class rule and the protest committee decides that the board also broke the same rule in earlier races in the same event, the penalty may be imposed for all such races. No further *protest* is necessary.

64.5 Decisions Concerning Support Persons

- (a) When the protest committee decides that a *support person* who is a *party* to a hearing under rule 60.3(d) or 69 has broken a rule, it may
 - (1) issue a warning,
 - (2) exclude the person from the event or venue or remove any privileges or benefits, or
 - (3) take other action within its jurisdiction as provided by the rules.
- (b) The protest committee may also penalize a board that is a *party* to a hearing under rule 60.3(d) or 69 for the breach of the rule by a *support person* by changing the board's score in a single race, up to and including disqualification, when the protest committee decides that
 - (1) the board may have gained a competitive advantage as the result of the breach by the *support person*, or
 - (2) the *support person* committed a further breach after the protest committee warned the board orally following a previous hearing, that penalty may be imposed.

65 INFORMING THE PARTIES AND OTHERS

65.1 After making its decision, the protest committee shall promptly inform orally the *parties* to the hearing of the facts found, the applicable *rules*, the decision, the reasons for it, and any penalties imposed or redress given.

65.2 Unless there is good reason not to do so, after any hearing, including a hearing under rule 69, the protest committee may publish the information set out in rule 65.1. The protest committee may direct that the information is to be confidential to the *parties*.

65.3 When the protest committee penalizes a board under a measurement or a class rule, it shall send the above information to the relevant measurement or class rule authorities.

66 REOPENING A HEARING

The protest committee may reopen a hearing when it decides that it may have made a significant error, or when significant new evidence becomes available within a reasonable time.

67 DAMAGES

The question of damages arising from a breach of any *rule* shall be governed by the prescriptions, if any, of the national authority.

Note: There is no rule 68.

**SECTION C
MISCONDUCT**

69 MISCONDUCT

69.1 Obligation not to Commit Misconduct; Resolution

- (a) A competitor, board owner or *support person* shall not commit an act of misconduct.
- (b) Misconduct is:
 - (1) conduct that is a breach of good manners, a breach of good sportsmanship, or unethical behaviour; or
 - (2) conduct that may bring, or has brought the sport into disrepute.
- (c) An allegation of a breach of rule 69.1(a) shall be resolved in accordance with the provisions of rule 69. It shall not be grounds for a *protest* and rule 63.1 does not apply.

69.2 Action by a Protest Committee

- (a) A protest committee acting under this rule shall have at least three members.
- (b) When a protest committee, from its own observation or from information received from any source, including evidence taken during a hearing, believes a person may have broken rule 69.1(a), it shall decide whether or not to call a hearing.

- (c) When the protest committee needs more information to make the decision to call a hearing, it shall consider appointing a person or persons to conduct an investigation. These investigators shall not be members of the protest committee that will decide the matter.
- (d) When an investigator is appointed, all relevant information he gathers, favourable or unfavourable, shall be disclosed to the protest committee, and if the protest committee decides to call a hearing, to the *parties*.
- (e) If the protest committee decides to call a hearing, it shall promptly inform the person in writing of the alleged breach and of the time and place of the hearing and follow the procedures in rules 63.2, 63.3(a), 63.4, 63.6, 65.1, 65.2 and 66 except that:
 - (1) unless a person has been appointed by World Sailing, a person may be appointed by the protest committee to present the allegation.
 - (2) a person against whom an allegation has been made under this rule shall be entitled to have an advisor and a representative with him who may act on his behalf.
- (f) If the person
 - (1) provides good reason why he is unable to come to the hearing at the scheduled time, the protest committee shall reschedule it; or
 - (2) does not provide good reason and does not come to the hearing, the protest committee may conduct it without the person present.
- (g) The standard of proof to be applied is the test of the comfortable satisfaction of the protest committee, bearing in mind the seriousness of the alleged misconduct. However, if the standard of proof in this rule conflicts with the laws of a country, the national authority may, with the approval of World Sailing, change it with a prescription to this rule.
- (h) When the protest committee decides that a competitor or board owner has broken rule 69.1(a), it may take one or more of the following actions
 - (1) issue a warning;

- (2) change their board's score in one or more races, including disqualification(s) that may or may not be excluded from her series score;
 - (3) exclude the person from the event or venue or remove any privileges or benefits; and
 - (4) take any other action within its jurisdiction as provided by the *rules*.
- (i) When the protest committee decides that a *support person* has broken rule 69.1(a), rule 64.5 applies.
 - (j) If the protest committee
 - (1) imposes a penalty greater than one DNE;
 - (2) excludes the person from the event or venue; or
 - (3) in any other case if it considers it appropriate,
 it shall report its findings, including the facts found, its conclusions and decision to the national authority of the person or, for specific international events listed in the World Sailing Regulations, to World Sailing. If the protest committee has acted under rule 69.2(f)(2), the report shall also include that fact and the reasons for it.
 - (k) If the protest committee decides not to conduct the hearing without the person present, or if the protest committee has left the event and a report alleging a breach of rule 69.1(a) is received, the race committee or organizing authority may appoint the same or a new protest committee to proceed under this rule. If it is impractical for the protest committee to conduct a hearing, it shall collect all available information and, if the allegation seems justified, make a report to the national authority of the person or, for specific international events listed in the World Sailing Regulations, to World Sailing.

69.3 Action by a National Authority and World Sailing

The disciplinary powers, procedures and responsibilities of national authorities and World Sailing that apply are specified in the World Sailing Disciplinary Code. National authorities and World Sailing may impose further penalties, including suspension of eligibility, under that code.

SECTION D

APPEALS

70 APPEALS AND REQUESTS TO A NATIONAL AUTHORITY

Appeals and requests to a National Authority are not permitted.

PART 6

ENTRY AND QUALIFICATION

75 ENTERING AN EVENT

To enter an event, a board shall comply with the requirements of the organizing authority of the event. She shall be entered by

- (a) a member of a club or other organization affiliated to a World Sailing member national authority,
- (b) such a club or organization, or
- (c) a member of a World Sailing member national authority.

76 EXCLUSION OF BOARDS OR COMPETITORS

76.1 The organizing authority or the race committee may reject or cancel the entry of a board or exclude a competitor, subject to rule 76.3, provided it does so before the start of the first heat and states the reason for doing so. On request the board shall promptly be given the reason in writing. The board may request redress if she considers that the rejection or exclusion is improper.

76.2 The organizing authority or the race committee shall not reject or cancel the entry of a board or exclude a competitor because of advertising, provided the board or competitor complies with the World Sailing Advertising Code.

76.3 At world and continental championships no entry within stated quotas shall be rejected or cancelled without first obtaining the approval of the relevant World Sailing Class Association or World Sailing.

77 IDENTIFICATION ON SAILS

A board shall comply with the requirements of Appendix G governing class insignia, national letters and numbers on sails.

78 COMPLIANCE WITH CLASS RULES; CERTIFICATES

78.1 While a board is *racing*, her owner and the competitor shall ensure that the board is maintained to comply with her class rules and that her measurement certificate, if any, remains valid. In addition, the board shall also comply at other times specified in the class rules, the notice of race or the sailing instructions. When so prescribed by World Sailing or class rules, a numbered and dated device on a board and her fin, foil and rig shall serve as her measurement certificate.

78.2 When a *rule* requires a valid certificate to be produced or its existence verified before a board *races*, and this cannot be done, the board may *race* provided that the race committee receives a statement signed by the competitor that a valid certificate exists. The board shall produce the certificate or arrange for its existence to be verified by the race committee before the start of the last day of the event, or of the first series, whichever is earlier. The penalty for breaking this rule is disqualification without a hearing from all races of the event.

79 CATEGORIZATION

If the notice of race or class rules state that some or all competitors must satisfy categorization requirements, the categorization shall be carried out as described in the World Sailing Sailor Categorization Code.

80 RESCHEDULED EVENT

When an event is rescheduled to dates different from the dates stated in the notice of race, all boards entered shall be notified. The race committee may accept new entries that meet all the entry requirements except the original deadline for entries.

PART 7

RACE ORGANIZATION

85 CHANGES TO RULES

85.1 A change to a *rule* shall refer specifically to the *rule* and state the change. A change to a *rule* includes an addition to it or deletion of all or part of it.

85.2 A change to one of the following types of *rules* may be made only as shown below.

<i>Type of rule</i>	<i>Change only if permitted by</i>
Racing rule	Rule 86
Rule in a World Sailing code	A rule in the code
National authority prescription	Rule 88.2
Class rule	Rule 87
Rule in the notice of race	Rule 89.2(b)
Rule in the sailing instructions	Rule 90.2(c)
Rule in any other document governing the event	A rule in the document itself

86 CHANGES TO THE RACING RULES

86.1 A racing rule shall not be changed unless permitted in the rule itself or as follows:

- (a) Prescriptions of a national authority may change a racing rule, but not the Definitions; the Basic Principles; a rule in the Introduction; Part 1, 2 or 7; rule 43, 47, 50, 63.4, 69, 70, 75, 76.3 or 79; a rule of an appendix that changes one of these rules; Appendix H or N; or a rule in a World Sailing Code listed in rule 6.1.
- (b) The notice of race or sailing instructions may change a racing rule, but not rule 76.1 or 76.2, or a rule listed in rule 86.1(a).
- (c) Class rules may change only racing rule 50.

86.2 In exception to rule 86.1, World Sailing may in limited circumstances (see World Sailing Regulation 28.1.3) authorize changes to the racing rules for a specific international event. The authorization shall be stated in a letter of approval to the organizing authority and in the notice of race or sailing instructions, and the letter shall be posted on the official notice board.

86.3 If a national authority so prescribes, the restrictions in rule 86.1 do not apply if rules are changed to develop or test proposed rules. The national authority may prescribe that its approval is required for such changes. The organizing authority shall report the changes and their results as soon as possible after the event ended to the International Funboard Class Association.

87 CHANGES TO CLASS RULES

The notice of race may change a class rule only when the class rules permit the change, or when written permission of the class association for the change is posted on the official notice board.

88 NATIONAL PRESCRIPTIONS

88.1 Prescriptions that Apply

The prescriptions that apply to an event are the prescriptions to the Racing Rules of Sailing of the national authority with which the organizing authority is associated under rule 89.1.

88.2 Changes to Prescriptions

The notice of race or sailing instructions may change a prescription. However, a national authority may restrict changes to its prescriptions with a prescription to this rule, provided World Sailing approves its application to do so. The restricted prescriptions shall not be changed.

89 ORGANIZING AUTHORITY; NOTICE OF RACE; APPOINTMENT OF RACE OFFICIALS

89.1 Organizing Authority

Races shall be organized by an organizing authority, which shall be

- (a) World Sailing;
- (b) a member national authority of World Sailing;
- (c) an affiliated club;
- (d) an affiliated organization other than a club and, if so prescribed by the national authority, with the approval of the national authority or in conjunction with an affiliated club;
- (e) an unaffiliated class association, either with the approval of the national authority or in conjunction with an affiliated club;
- (f) two or more of the above organizations;

- (g) an unaffiliated body in conjunction with an affiliated club where the body is owned and controlled by the club. The national authority of the club may prescribe that its approval is required for such an event; or
- (h) if approved by World Sailing and the national authority of the club, an unaffiliated body in conjunction with an affiliated club where the body is not owned and controlled by the club.

In rule 89.1, an organization is affiliated if it is affiliated to the national authority of the venue; otherwise the organization is unaffiliated.

89.2 Notice of Race; Appointment of Race Officials

- (a) The organizing authority shall publish a notice of race that conforms to rule J1.
- (b) The notice of race may be changed provided adequate notice is given.
- (c) The organizing authority shall appoint a race committee and, when appropriate, appoint a protest committee, a technical committee. However, the race committee, an international jury, a technical committee may be appointed by World Sailing as provided in its Regulations.

90 RACE COMMITTEE; SAILING INSTRUCTIONS; SCORING

90.1 Race Committee

The race committee shall conduct races as directed by the organizing authority and as required by the *rules*.

90.2 Sailing Instructions

- (a) The race committee shall publish written sailing instructions that conform to rule J2.
- (b) When appropriate, for an event where entries from other countries are expected, the sailing instructions shall include, in English, the applicable national prescriptions.
- (c) The sailing instructions may be changed provided the change is in writing and posted on the official notice board before the time stated in the sailing instructions or, on the water, communicated to each board before her attention signal. Oral instructions may be given if the procedure is stated in the sailing instructions.

90.3 Scoring

- (a) The race committee shall score heats and eliminations as provided in Appendix A, unless the notice of race or sailing instructions specify some other system. A race shall be scored if it is not *abandoned* and if one board *starts, sails the course* and *finishes* within the race time limit, if any, even if she retires after *finishing* or is disqualified.
- (b) When a scoring system provides for excluding one or more race scores, any score that is a Disqualification Not Excludable (DNE) shall be included in a board's series score.
- (c) When the race committee determines from its own records or observations that it has scored a board incorrectly, it shall correct the error and make the corrected scores available to competitors.
- (d) The race committee shall implement scoring changes directed by the protest committee or national authority as a result of decisions made in accordance with the *rules*.
- (e) When so stated in the notice of race, notwithstanding the provisions of rules 90.3(a), (b), (c) and (d), there shall be no changes to race or series scores resulting from action, including the correction of errors, initiated more than 24 hours after
 - (1) the protest time limit for the last race of the series (including a single-race series);
 - (2) being informed of a protest committee decision after the last race of the series (including a single-race series); or
 - (3) the results are published.

However, in exception, changes to scores shall be made resulting from a decision under rules 6 or 69. The notice of race may change '24 hours' to a different time.

91 PROTEST COMMITTEE

A protest committee shall be

- (a) a committee appointed by the organizing authority or race committee;

- (b) an international jury appointed by the organizing authority or as prescribed in the World Sailing Regulations. It shall be composed as required by rule N1 and have the authority and responsibilities stated in rule N2. A national authority may prescribe that its approval is required for the appointment of international juries for races within its jurisdiction, except World Sailing events or when international juries are appointed by World Sailing under rule 89.2(c).

92 TECHNICAL COMMITTEE

- 92.1** A technical committee shall be a committee of at least one member and be appointed by the organizing authority, or as prescribed in the World Sailing Regulations.
- 92.2** The technical committee shall conduct equipment inspection and event measurement as directed by the organizing authority and as required by the rules. The technical committee shall be the interpreting authority in rule 64.3(b).

APPENDIX A

SCORING

See rule 90.3.

A1 HEATS, ROUNDS AND ELIMINATION SERIES

A1.1 The slalom event shall consist of one or more eliminations which constitute the elimination series of the slalom event. The top competitors in each heat will qualify for the next round. The number of the competitors in each heat shall be stated in the sailing instructions.

A1.2 The number of heats in the round, the number of rounds in an elimination and the number of eliminations required to be completed to constitute the elimination series of the slalom event shall be stated in the sailing instructions.

To complete an elimination, the competitors in A-final and B-final shall be defined.

If an event includes more than one discipline or format, the notice of race shall state how the overall scores will be calculated.

A1.3 Examples of Slalom Eliminations, named Ladders, and Slalom Distribution Table and courses are given in Addendums to these WSRR.

A2 SERIES SCORES

A2.1 Each board's elimination series score shall, subject to rule 90.3(b), be the total of her elimination scores excluding her

- (a) worst score when from 3 or 4 eliminations are completed,
- (b) two worst scores when from 5 or 6 eliminations are completed,
- (c) three worst scores when 7 or more eliminations are completed.

However, the notice of race or sailing instructions may make a different arrangement. A heat is completed if scored; see rule 90.3(a). If a board has two or more equal worst scores, the score(s) for the elimination(s) sailed earliest in the elimination series shall be excluded. The board with the lowest elimination series score wins and others shall be ranked accordingly.

A2.2 If a board has entered any heat in an elimination, she shall be scored for the elimination.

A2.3 If a board has been scored in any elimination, she shall be scored for the whole elimination series.

A3 STARTING TIMES AND FINISHING PLACES

The time of a board's starting signal shall be her starting time, and the order in which boards *finish* a heat shall determine their finishing places according to the Ladder.

A4 SCORING SYSTEM

This Low Point System will apply unless the notice of race or sailing instructions specify another system; see rule 90.3(a).

Each board, except board given redress, shall be scored points as follows:

<i>Finishing place</i>	<i>Points</i>
First	0
Second	2
Third	3
Fourth	4
Fifth	5
Each place thereafter	Add 1 point

A5 SCORES DETERMINED BY THE RACE COMMITTEE

A5.1 A board that did not *start, sail the course* or *finish*, or comply with rule 29 or 78.2, or that retires, shall be scored accordingly by the race committee without a hearing. Only the protest committee may take other scoring actions that worsen a board's score.

A5.2 A board that did not *start*, did not *sail the course*, did not *finish*, retired or was penalized under rule 29 or was disqualified shall be ranked at the last place of the heat. A board that is disqualified in a heat and the disqualification is not excludable (DNE) shall be scored points equal to the last place of the elimination.

A5.3 When a heat in the last round cannot be completed, the points for the unscored places shall be added together and divided by the number of places in that heat. The resulting number of points, to be nearest tenth of a point (0.05 to be rounded upward), shall be given to each board entered in the heat.

A6 CHANGES IN PLACES AND SCORES OF OTHER BOARDS

A6.1 If a board is disqualified from a race or retires after *finishing*, each board with a worse finishing place shall be moved up one place.

A6.2 If the protest committee decides to give redress by adjusting a board's score, the scores of other boards shall not be changed unless the protest committee decides otherwise.

A7 ELIMINATION SERIES TIES

A7.1 If there is an elimination series-score tie between two or more boards, they shall be ranked in order of their best excluded elimination score.

A7.2 If a tie remains between two or more boards, each board's elimination scores, including excluded scores, shall be listed in order of best to worst, and at the first point(s) where there is a difference the tie shall be broken in favour of the board(s) with the best score(s). These scores shall be used even if some of them are excluded scores.

A7.3 If a tie still remains between two or more boards, they shall be ranked in order of their scores in the last elimination. Any remaining ties shall be broken by using the tied boards' scores in the next-to-last elimination and so on until all ties are broken. These scores shall be used even if some of them are excluded scores.

A8 RACE SCORES IN AN ELIMINATION SERIES LONGER THAN A REGATTA

For an elimination series that is held over a period of time longer than a regatta, a board that came to the starting area but did not *start*, did not *finish*, retired or was disqualified shall be scored points for the finishing place one more than the number of boards that came to the starting area. A board that did not come to the starting area shall be scored points for the finishing place one more than the number of boards entered in the elimination series.

A9 GUIDANCE ON REDRESS

If the protest committee decides to give redress by adjusting a board's score for a heat, it is advised to consider:

- (a) in the last round of an elimination, scoring her points equal to the average, to the nearest tenth of a point (0.05 to be rounded upward), of her points in all the eliminations in the series, except the elimination in question, but not worse than her finishing position or the last place in her heat, and not better than the best place in her heat, or
- (b) in all other rounds, advancing her to the next round, without changing the finishing place of other boards, or

- (c) in any round, points based on the position of the board in the race at the time of the incident that justified redress.

A10 SCORING ABBREVIATIONS

These scoring abbreviations shall be used for recording the circumstances described:

DNC	Did not <i>start</i> ; did not come to the starting area
DNS	Did not <i>start</i> (other than DNC)
BFD	Disqualification under rule 29
NSC	Did not <i>sail the course</i>
DNF	Did not <i>finish</i>
RET	Retired
DSQ	Disqualification
DNE	Disqualification that is not excludable
RDG	Redress given
DPI	Discretionary penalty imposed

APPENDIX G

IDENTIFICATION ON SAILS

See rule 77.

G1 ALL BOARDS

G1.1 Identification

Every board shall carry on her sail

- (a) the insignia denoting her class;
- (b) at all international events, except when the boards are provided to all competitors, national letters denoting her national authority from the table available on the World Sailing website. For the purposes of this rule, international events are World Sailing events, world and continental championships, and events described as international events in their notices of race and sailing instructions; and
- (c) a sail number allotted by her national authority or, when so required by the class rules, by the class association. Alternatively, if permitted in the class rules, an owner may be allotted a personal sail number by the relevant issuing authority, which may be used on all his boards in that class.

G1.2 Specifications

- (a) National letters and sail numbers shall be:
 - (1) in capital letters and Arabic numerals,
 - (2) of the same colour,
 - (3) of a contrasting colour to the body of the sail, and
 - (4) of a sans-serif typeface.

In addition, the letters and numbers identifying the board shall be clearly legible when the sail is set.

- (b) The height of characters and space between adjoining characters on the same and opposite sides of the sail shall be of a minimum height of 230mm and the space between characters and from the edge of the sail shall be a minimum of 45mm.

NATIONAL SAIL LETTERS

<i>National authority</i>	<i>Letters</i>	<i>National authority</i>	<i>Letters</i>
Algeria	ALG	Djibouti	DJI
American Samoa	ASA	Dominican Republic	DOM
Andorra	AND	Ecuador	ECU
Angola	ANG	Egypt	EGY
Antigua	ANT	El Salvador	ESA
Argentina	ARG	Estonia	EST
Armenia	ARM	Fiji	FIJ
Aruba	ARU	Finland	FIN
Australia	AUS	France	FRA
Austria	AUT	Georgia	GEO
Azerbaijan	AZE	Germany	GER
Bahamas	BAH	Great Britain	GBR
Bahrain	BRN	Greece	GRE
Barbados	BAR	Grenada	GRN
Belarus	BLR	Guam	GUM
Belgium	BEL	Guatemala	GUA
Belize	BIZ	Hong Kong, China	HKG
Bermuda	BER	Hungary	HUN
Brazil	BRA	Iceland	ISL
Botswana	BOT	India	IND
British Virgin Islands	IVB	Indonesia	INA
Brunei Darussalam	BRU	Iran	IRN
Bulgaria	BUL	Iraq	IRQ
Cambodia	CAM	Ireland	IRL
Canada	CAN	Israel	ISR
Cayman Islands	CAY	Italy	ITA
Chile	CHI	Jamaica	JAM
China, PR	CHN	Japan	JPN
Chinese Taipei	TPE	Kazakhstan	KAZ
Colombia	COL	Kenya	KEN
Cook Islands	COK	Korea, DPR	PRK
Croatia	CRO	Korea, Republic of	KOR
Cuba	CUB	Kosovo	KOS
Cyprus	CYP	Kuwait	KUW
Czech Republic	CZE	Kyrgyzstan	KGZ
Denmark	DEN	Latvia	LAT

<i>National authority</i>	<i>Letters</i>
Lebanon	LIB
Libya	LBA
Liechtenstein	LIE
Lithuania	LTU
Luxembourg	LUX
Macau, China	MAC
Madagascar	MAD
Malaysia	MAS
Malta	MLT
Mauritius	MRI
Mexico	MEX
Moldova	MDA
Monaco	MON
Montenegro	MNE
Montserrat	MNT
Morocco	MAR
Mozambique	MOZ
Myanmar	MYA
Namibia	NAM
Netherlands	NED
Netherlands Antilles	AHO
New Zealand	NZL
Nigeria	NGR
North Macedonia	MKD
Norway	NOR
Oman	OMA
Pakistan	PAK
Palestine	PLE
Panama	PAN
Papua New Guinea	PNG
Paraguay	PAR
Peru	PER
Philippines	PHI
Poland	POL
Portugal	POR
Puerto Rico	PUR
Qatar	QAT

<i>National authority</i>	<i>Letters</i>
Romania	ROM
Russia	RUS
Samoa	SAM
San Marino	SMR
Senegal	SEN
Serbia	SRB
Seychelles	SEY
Singapore	SGP
Slovak Republic	SVK
Slovenia	SLO
South Africa	RSA
Spain	ESP
Sri Lanka	SRI
St Kitts & Nevis	SKN
St Lucia	LCA
Sudan	SUD
Sweden	SWE
Switzerland	SUI
Tahiti	TAH
Tanzania	TAN
Thailand	THA
Timore Leste	TLS
Trinidad & Tobago	TTO
Tunisia	TUN
Turkey	TUR
Turks & Caicos	TKS
Uganda	UGA
Ukraine	UKR
United Arab Emirates	UAE
United States of America	USA
Uruguay	URU
US Virgin Islands	ISV
Vanuatu	VAN
Venezuela	VEN
Vietnam	VIE
Zimbabwe	ZIM

G1.3 Positioning

Class insignia, national letters and sail numbers shall be positioned as follows:

- (a) The class insignia shall be displayed once on each side of the sail in the area above a line projected at right angles from a point on the luff of the sail one-third of the distance from the head to the wishbone. The national letters and sail numbers shall be in the central third of that part of the sail above the wishbone, clearly separated from any advertising. They shall be applied back to back either white on a black background or black on a opaque; white background. The background shall extend a minimum of 30 mm beyond the characters. There shall be a ‘-’ between the national letters and the sail number, and the spacing between characters shall be adequate for legibility.
- (b) If the class insignia is of such a design that two of them coincide when placed back to back on both sides of the sail, they may be so placed.

G2 Deleted.

G3 CHARTERED OR LOANED BOARDS

When so stated in the notice of race or sailing instructions, a board chartered or loaned for an event may carry national letters or a sail number in contravention of her class rules.

G4 WARNINGS AND PENALTIES

When a protest committee finds that a board has broken a rule of this appendix, it shall either warn her and give her time to comply or penalize her.

G5 CHANGES BY CLASS RULES

World Sailing Classes may change the rules of this appendix provided the changes have first been approved by World Sailing.

APPENDIX H

WEIGHING CLOTHING AND EQUIPMENT

See rule 50. This appendix shall not be changed by the notice of race, sailing instructions or prescriptions of national authorities.

- H1** Items of clothing and equipment to be weighed shall be arranged on a rack. After being saturated in water the items shall be allowed to drain freely for one minute before being weighed. The rack must allow the items to hang as they would hang from clothes hangers, so as to allow the water to drain freely. Pockets that have drain-holes that cannot be closed shall be empty, but pockets or items that can hold water shall be full.
- H2** When the weight recorded exceeds the amount permitted, the competitor may rearrange the items on the rack and the member of the technical committee in charge shall again soak and weigh them. This procedure may be repeated a second time if the weight still exceeds the amount permitted.
- H3** A competitor wearing a dry suit may choose an alternative means of weighing the items.
- (a) The dry suit and items of clothing and equipment that are worn outside the dry suit shall be weighed as described above.
 - (b) Clothing worn underneath the dry suit shall be weighed as worn while racing, without draining.
 - (c) The two weights shall be added together.

APPENDIX J

NOTICE OF RACE AND SAILING INSTRUCTIONS

See rules 89.2 and 90.2. In this appendix, the term 'event' includes a race or series of races.

A rule in the notice of race need not be repeated in the sailing instructions.

Care should be taken to ensure that there is no conflict between rules in the notice of race, the sailing instructions or any other document that governs the event,

J1 NOTICE OF RACE CONTENTS

J1.1 The notice of race shall include the following:

- (1) the title, place and dates of the event and name of the organizing authority;
- (2) that the event will be governed by the *rules* as defined in *The Windsurfing Slalom Racing Rules*;
- (3) a list of any other documents that will govern the event (for example, *The Equipment Rules of Sailing*, to the extent that they apply), stating where or how each document or an electronic copy of it may be obtained;
- (4) the classes to race, any handicap or rating system that will be used, and the classes to which it will apply; conditions of entry and any restrictions on entries;
- (5) the procedures and times for registration or entry, including fees and any closing dates;
- (6) the times warning signals for the practice race, if one is scheduled, and the first race, and succeeding races if known.

J1.2 The notice of race shall include any of the following that will apply:

- (1) times or procedures for equipment inspection or event measurement, or requirements for measurement or rating certificates;
- (2) changes to the racing rules authorized by World Sailing under rule 86.2, referring specifically to each rule and stating the change (also include the statement from World Sailing authorizing the change);
- (3) changes to class rules, as permitted under rule 87, referring specifically to each rule and stating the change;
- (4) categorization or classification requirements that some or all competitors must satisfy;
 - (a) for sailor categorization (see rule 79 and the World Sailing Sailor Categorization Code), or
 - (b) for functional classification for Para World Sailing events (see World Sailing Para Classification Rules);
- (5) that boards will be required to display advertising chosen and supplied by the organizing authority (see rule 6 and the World Sailing Advertising Code) and other information related to advertising;
- (6) when entries from other countries are expected, any national prescriptions that may require advance preparation (see rule 88);
- (7) the procedures for registration or entry, including fees and any closing dates;
- (8) any requirements necessary for compliance with data protection legislation that applies in the venue of the event;
- (9) an entry form, to be signed by the board's owner or owner's representative, containing words such as 'I agree to be bound by *The Windsurfing Slalom Racing Rules* and by all other *rules* that govern this event.';

J1.3 The notice of race shall include any of the following that will apply and that would help competitors decide whether to attend the event or that conveys other information they will need before the sailing instructions become available:

- (1) changes to the racing rules permitted by rule 86, referring specifically to each rule and stating the change;
- (2) changes to the national prescriptions (see rule 88.2);

- (3) the time and place at which the sailing instructions will be available;
- (4) a general description of the course, or type of courses, to be sailed;
- (5) the scoring system, if different from the system in Appendix A, included by reference to class rules or other *rules* governing the event, or stated in full. State the number of races scheduled and the minimum number that must be completed to constitute a series. If appropriate, for a series where the number of starters may vary substantially, state that rule A5.3 applies;
- (6) the time after which no warning signal will be made on the last scheduled day of racing;
- (7) for chartered or loaned boards, whether rule G3 applies;
- (8) prizes.

J2 SAILING INSTRUCTION CONTENTS

J2.1 Unless included in the notice of race, the sailing instructions shall include the following:

- (1) that the race will be governed by the *rules* as defined in *The Windsurfing Slalom Racing Rules*;
- (2) a list of any other documents that will govern the event (for example, *The Equipment Rules of Sailing*, to the extent that they apply);
- (3) the schedule of races, the classes to race and times of warning signals for each class;
- (4) a complete description of the course(s) to be sailed, or a list of *marks* from which the course will be selected and, if relevant, how courses will be signalled;
- (5) descriptions of *marks*, including starting and finishing *marks*, stating the order in which *marks* are to be passed and the side on which each is to be left and identifying all rounding *marks* (see the definition *Sail the Course*);
- (6) descriptions of the starting and finishing lines, class flags and any special signals to be used;
- (7) the race time limit, if any, for *finishing*;

- (8) location(s) of official notice board(s) or address of online notice board; location of the race office.

J2.2 Unless included in the notice of race, the sailing instructions shall include those of the following that will apply:

- (1) that boards will be required to display advertising chosen and supplied by the organizing authority (see rule 80 and World Sailing Regulation 20, Advertising Code) and other information related to Regulation 20;
- (2) changes to the racing rules permitted by rule 86, referring specifically to each rule and stating the change (also, if rule 86.2 applies, include the statement from World Sailing authorizing the change);
- (3) changes to the national prescriptions (see rule 88.2);
- (4) prescriptions that will apply if boards will pass through the waters of more than one national authority while *racing*, and when they will apply (see rule 88.1);
- (5) when appropriate, at an event where entries from other countries are expected, a copy in English of the national prescriptions that will apply;
- (6) changes to class rules, as permitted under rule 87, referring specifically to each rule and stating the change;
- (7) restrictions controlling changes to boards when supplied by the organizing authority;
- (8) unless included in the notice of race, times or procedures for equipment inspection or event measurement;
- (9) procedure for changing the sailing instructions;
- (10) procedure for giving oral changes to the sailing instructions on the water (see rule 90.2(c));
- (11) safety requirements, such as requirements and signals for personal flotation devices, check-in at the starting area, and check-out and check-in ashore;
- (12) declaration requirements;
- (13) signals to be made ashore and location of signal station(s);

- (14) the racing area (a chart is recommended);
- (15) approximate course length and approximate length of windward legs;
- (16) description of any object, area or line designated by the race committee to be an *obstruction* (see the definition *Obstruction*), and any restriction on entering such an area or crossing such a line;
- (17) the time after which no warning signal will be made on the last scheduled day of racing;
- (18) the time limit, if any, for boards other than the first board to *finish* and any other time limits or target times that apply while boards are *racing*;
- (19) time allowances;
- (20) location of the starting area and any restrictions on entering it;
- (21) boards identifying *mark* locations;
- (22) restrictions on use of support boards, plastic pools, radios, etc.; on trash disposal; on hauling out; and on outside assistance provided to a board that is not *racing*;
- (23) time limits, place of hearings, and special procedures for *protests*, requests for redress or requests for reopening;
- (24) the national authority's approval of the appointment of an international jury, when required under rule 91(b);
- (25) substitution of competitors;
- (26) the minimum number of boards appearing in the starting area required for a race to be started;
- (27) when and where races *postponed* or *abandoned* for the day will be sailed;
- (28) tides and currents;
- (29) other commitments of the race committee and obligations of boards.

NOTICE OF RACE GUIDE

Previously Appendix K

SAILING INSTRUCTIONS GUIDE

Previously Appendix L

These guides, updated to conform to the rules in this edition of The Racing Rules of Sailing, are available, in various formats, at the World Sailing website at sailing.org/racingrules/documents. National authorities are encouraged to translate the guides, and World Sailing will make translated versions available at that website.

The guides, which will have a two-letter designation starting with 'K' or 'L', may be downloaded either as PDF documents or as Word documents. This will enable users to easily and quickly create, using the tested wording in the guides, either the notice of race or the sailing instructions, or both, for a particular event.

Suggestions for improving these guides are welcome and should be sent to rules@sailing.org.

APPENDIX N

INTERNATIONAL JURIES

See rule 91(b). This appendix shall not be changed by the notice of race, sailing instructions or national prescriptions.

N1 COMPOSITION, APPOINTMENT AND ORGANIZATION

- N1.1** An international jury shall be composed of experienced sailors with excellent knowledge of the racing rules and extensive protest committee experience. It shall be independent of and have no members from the race committee or the technical committee, and it shall be appointed by the organizing authority, subject to approval by the national authority if required (see rule 91(b)), or by World Sailing under rule 89.2(c).
- N1.2** The jury shall consist of a chairman, a vice chairman if desired, and other members for a total of at least three. A majority shall be International Judges.
- N1.3** The members shall be from at least three different national authorities.
- N1.4** (a) The chairman of a jury may appoint one or more panels composed of two or more judges. Half or more shall be International Judges if possible. A panel decision is final.
- (b) Deleted.
- N1.5** Deleted.
- N1.6** When it is considered desirable that some members not participate in discussing and deciding a *protest* or request for redress, and no qualified replacements are available, the jury or panel remains properly constituted if at least two members remain. Half or more shall be International Judges.
- N1.7** Deleted.
- N1.8** When the national authority's approval is required for the appointment of an international jury (see rule 91(b)), notice of its approval shall be included in the sailing instructions or be posted on the official notice board.
- N1.9** Deleted.

N2 RESPONSIBILITIES

- N2.1** An international jury is responsible for hearing and deciding all *protests*, requests for redress and other matters arising under the rules of Part 5. When asked by the organizing authority, the race committee or technical committee, it shall advise and assist them on any matter directly affecting the fairness of the competition.
- N2.2** Unless the organizing authority directs otherwise, the jury shall decide
- (a) questions of eligibility, measurement certificates; and
 - (b) whether to authorize the substitution of competitors, boards or equipment when a *rule* requires such a decision.
- N2.3** The jury shall also decide matters referred to it by the organizing authority, the race committee or technical committee.

N3 PROCEDURES

- N3.1** Members shall not be regarded as having a significant *conflict of interest* (see rule 63.4) by reason of their nationality, club membership or similar. When otherwise considering a significant *conflict of interest* as required by rule 63.4, considerable weight must be given to the fact that decisions of an international jury cannot be appealed and this may affect the perception of fairness and lower the level of conflict that is significant. In case of doubt, the hearing should proceed as permitted by rule N1.6.
- N3.2** If a panel fails to agree on a decision it may adjourn, in which case the chairman shall refer the matter to a properly constituted panel with as many members as possible, which may be the full jury.

N4 MISCONDUCT (Rule 69)

- N4.1** The World Sailing Disciplinary Code, contains procedures that apply to specific international events with regard to the appointment of a person to conduct any investigation. These procedures override any conflicting provision of this appendix.
- N4.2** A person shall be responsible for presenting to the hearing panel any allegations of misconduct under rule 69. This person shall not be a member of the hearing panel but may be a member of the jury. Such a person shall be required to make full disclosure of all material that may come into his possession in the course of his investigation to the person subject to allegations of a breach of rule 69.

- N4.3** Prior to a hearing, the hearing panel, to the extent practically possible, shall not act as an investigator of any allegations made under rule 69. However, during the hearing the panel shall be entitled to ask any investigative questions it may see fit.
- N4.4** If the panel decides to call a hearing, all material disclosed to the panel in order for them to make that decision must be disclosed to the person subject to the allegations before the hearing begins.

ADDENDUM 1

ELIMINATION LADDERS

SLALOM LADDER A

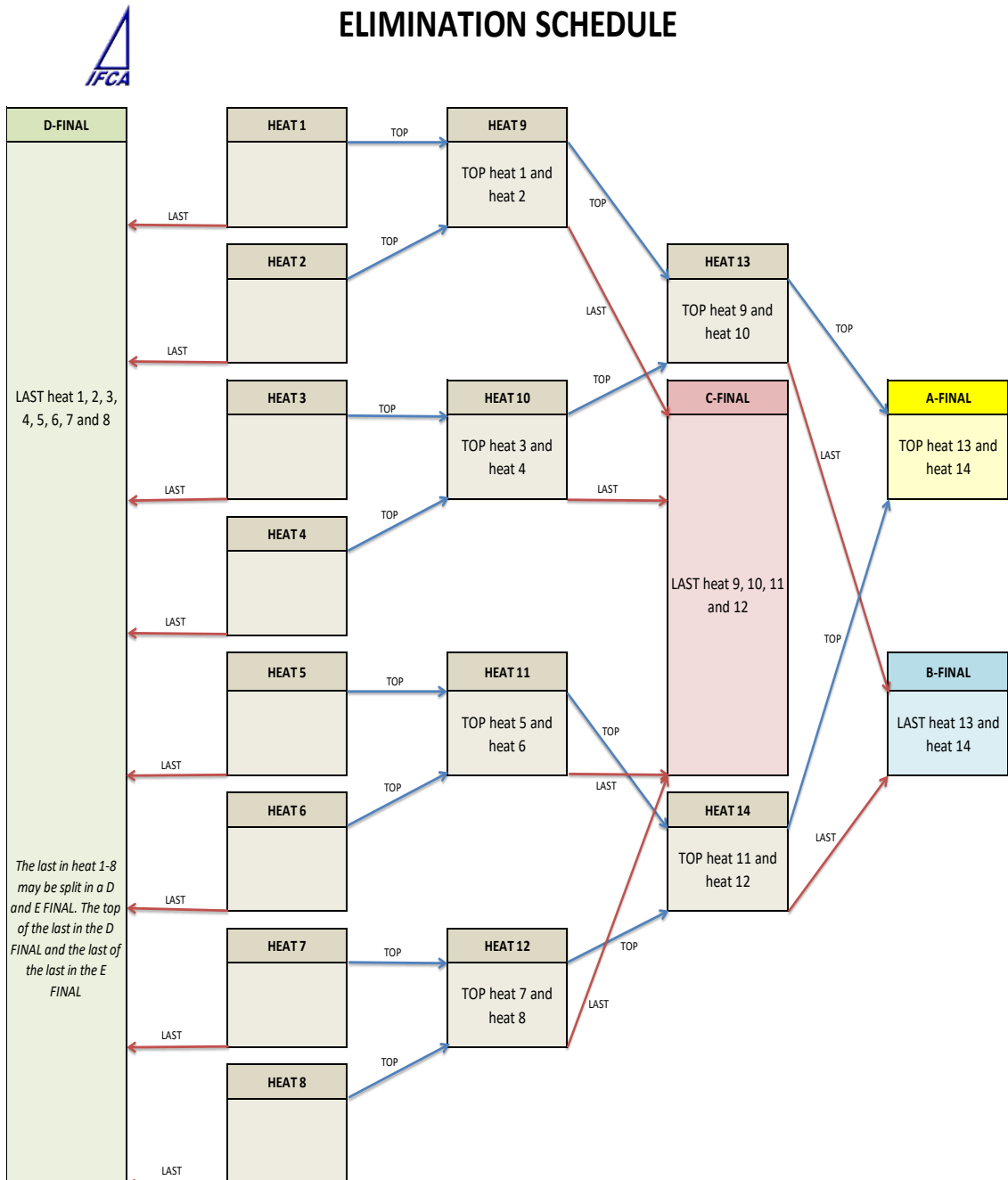

SLALOM LADDER B



ELIMINATION SCHEDULE

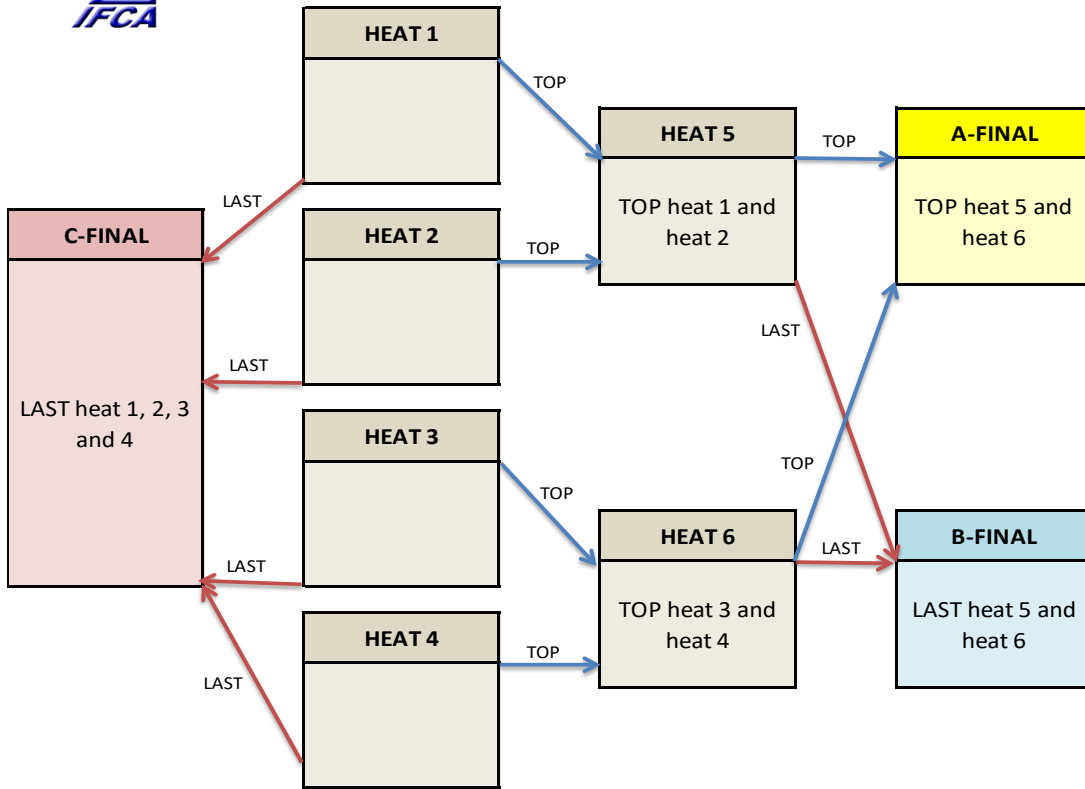

SLALOM LADDER C



ELIMINATION SCHEDULE

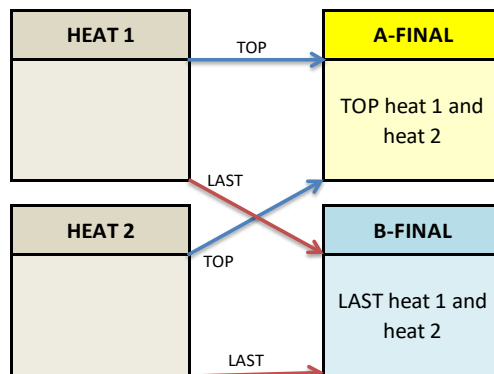

ADDENDUM 2

ELIMINATION SCHEDULE

Slalom Distribution Table											
Maximum 80 Competitors				Maximum 40 Competitors				Maximum 20 Competitors			
Heat No	Competitor No			Heat No	Competitor No			Heat No	Competitor No		
1	6	38	70	1	3	19	35	1			
	11	43	75		6	22	38				
	22	54			11	27			2	10	18
	27	59			14	30			3	11	19
2	3	35	67	2	2	18	34	2			
	14	46	78		7	23	39		6	14	
	19	51			10	26			7	15	
	30	62			15	31					
3	7	39	71	3	4	20	36	2			
	10	42	74		5	21	37				
	23	55			12	28			1	9	17
	26	58			13	29			4	12	20
4	2	34	66	4	1	17	33	2			
	15	47	79		8	24	40		5	13	
	18	50			9	25			8	16	
	31	63			16	32					
5	5	37	69	4				2			
	12	44	76								
	21	53									
	28	60									
6	4	36	68								
	13	45	77								
	20	52									
	29	61									
7	8	40	72								
	9	41	73								
	24	56									
	25	57									
8	1	33	65								
	16	48	80								
	17	49									
	32	64									

ADDENDUM 3

COURSES

FIGURE OF EIGHT SLALOM

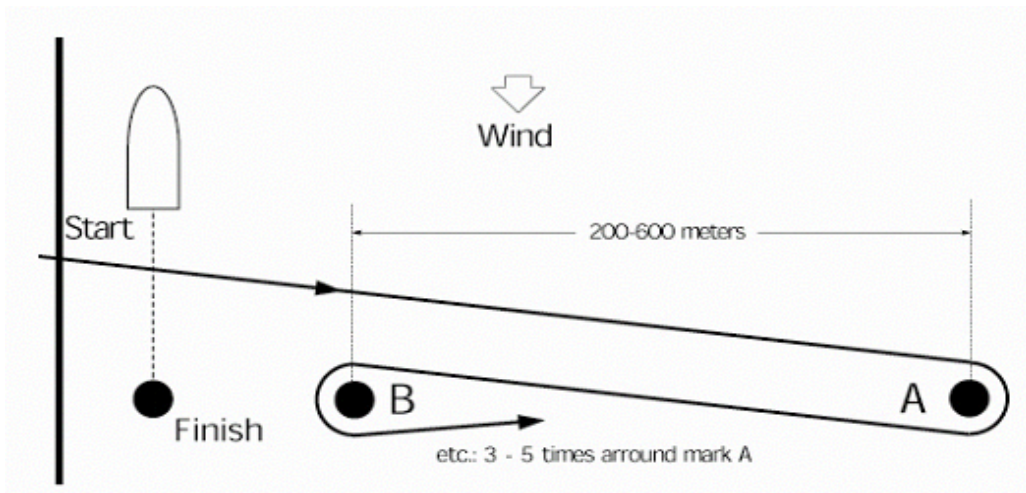

Note: The start can be from the beach or on the water near the marks A or B. If the wind is not cross shore starts should normally be on the water. The finish can be to windward or leeward of mark B, on the water or the beach.

DOWNWIND SLALOM

